



**AMSAT Italia**®



# **ASI Contribution to education in MAGISSTRA mission**

*Paolo Nespoli, IZØJPA / IRØISS  
Astronaut of MAGISSTRA mission*

*Francesco De Paolis, IKØWGF  
Secretary - AMSAT Italia*

*ARISS International Delegates Meeting  
October 28-29, 2011 - Houston*

- ASI and AMSAT Italia MoU;
- ASI publications and education subsidies;
- ASI sustain to ARISS - AMSAT Italia initiatives;
- ISS 26 / 27 and ARISS Schedule;
- Student's works;
- Radio Amateur station's layout;
- Shared and double contacts;
- Italian radio amateur voluntary groups;
- Video Streaming, ESA announcements.

ASI and AMSAT Italia have signed a MoU under which:

- AMSAT Italia will carry out School Contacts within ARISS framework;
- AMSAT Italia will promote innovative projects in its specific field;
- ASI will provide educational tools;
- ASI staff will assist AMSAT Italia in their projects;
- ASI and AMSAT Italia to promote the Italian space activities in the world;

# ASI 3D PUZZLE



*An example of a satellite puzzle provided by ASI for educational purposes to students attending ARISS contacts through radio amateur stations with ISS astronauts*



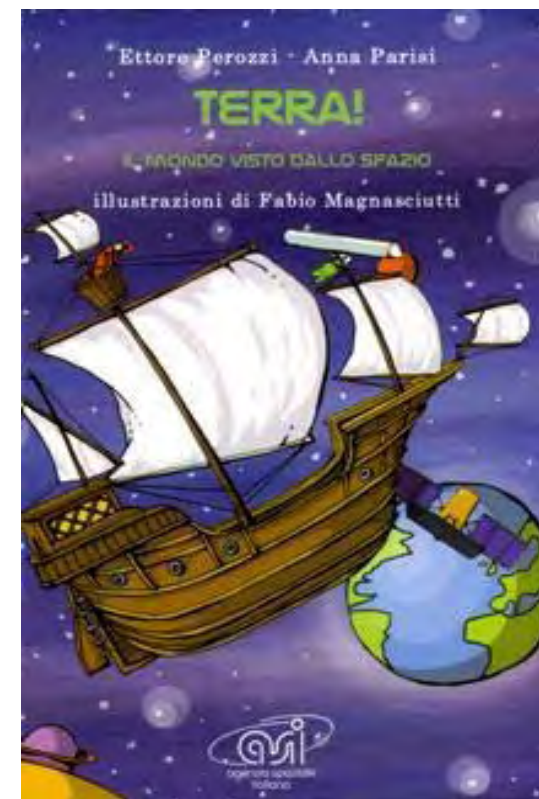
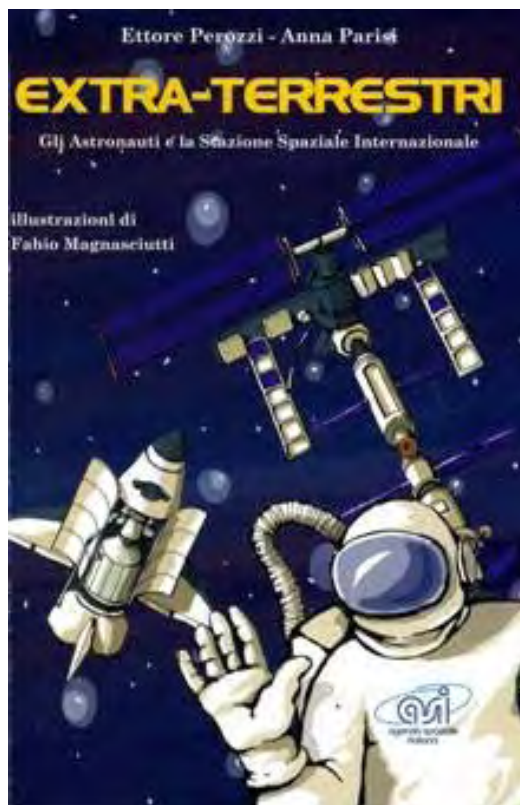

*For students of primary and middle schools ASI has published booklets on many issues:  
International Space Station, research on micro particles, earth observation*

**ARISS International Delegates Meeting - October 28-29, 2011- Houston**



AMSAT Italia®

## ASI President Enrico Saggese, IWODGF in contact with Astronaut Paolo Nespoli, IZOJPA



Saturday, 15 January the "Istituto Via Toscana 2" in Civitavecchia, Rome, Italy, established a double contact with Paolo Nespoli, IZOJPA on board the ISS.

At 09:02 UTC, contact with IROISS was established by station IKOWGF. Astronaut Paolo Nespoli answered 12 questions **and before LOS the President of ASI (Italian Space Agency) and radio amateur Enrico Saggese, IWODGF exchanged greetings with Paolo Nespoli, IZOJPA.**



At 10:37 UTC, contact with IROISS was again established by station IKOWGF.

**Paolo NESPOLI** answered 8 more questions and talked about the 10th anniversary of the 1st ARISS contact emphasizing the importance of ARISS school contacts.

***ARISS International Delegates Meeting - October 28-29, 2011- Houston***



# ISS 26-27 crew members



Position	First part (November 2010)	Second part (December 2010 <sup>[2]</sup> [19] to March 2011)
Commander	Scott J. Kelly, NASA Third spaceflight	
Flight Engineer	Aleksandr Kalen, RSA Fifth spaceflight	
Flight Engineer	Oleg Skripochka, RSA First spaceflight	
Flight Engineer		Dmitri Kondratyev, RSA First spaceflight
Flight Engineer		Catherine Coleman, NASA Third spaceflight
Flight Engineer		Paolo Nespoli, ESA Second spaceflight

Position	First Part (March 2011)	Second Part (April 2011 to May 2011)
Commander	Dmitri Kondratyev, RSA First spaceflight	
Flight Engineer	Catherine Coleman, NASA Third spaceflight	
Flight Engineer	Paolo Nespoli, ESA Second spaceflight	
Flight Engineer		Andrei Borisenko, RSA First spaceflight
Flight Engineer		Aleksandr Samokutyaev, RSA First spaceflight
Flight Engineer		Ron Garan, NASA Second spaceflight



AMSAT Italia®

# ARISS plan for ISS 26-27 crew

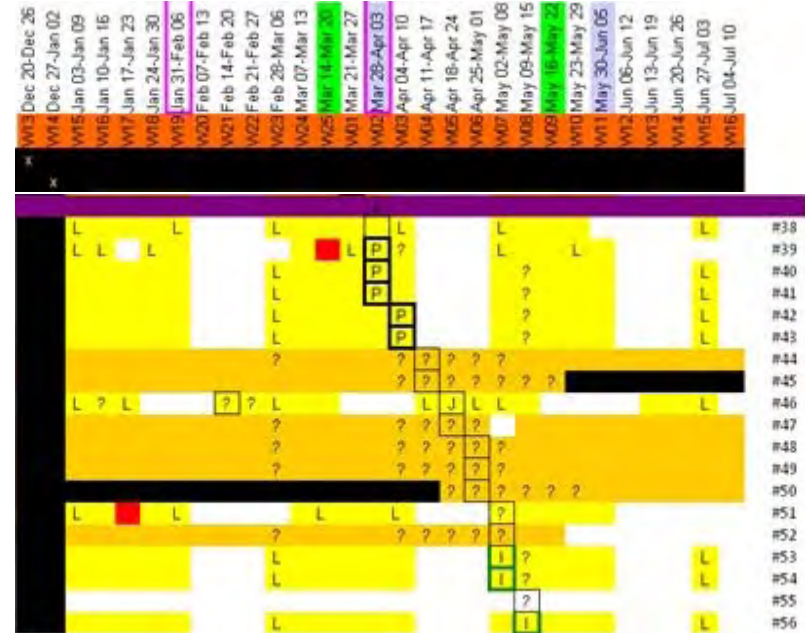
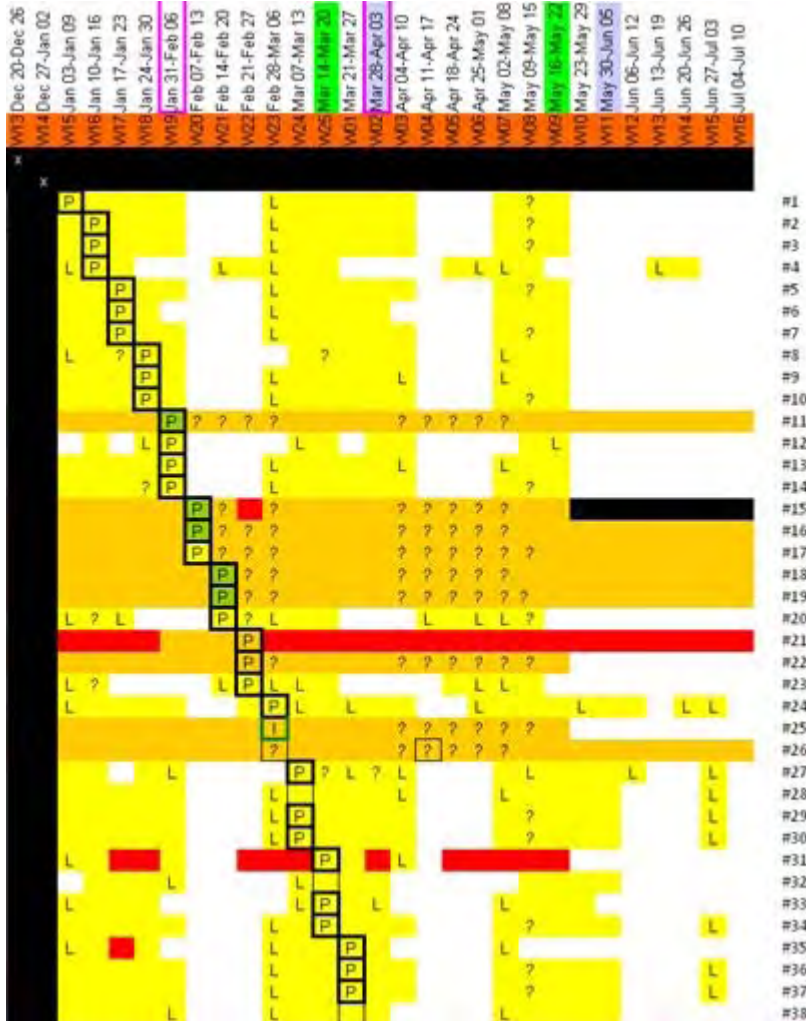

In August 2010 the ARISS best schedule of the number of school contacts by ISS 26/27 was **31**.

The final schedule of ARISS "school contacts" by ISS 26/27 before lift off was **56**, i.e. 25 more than August 2010 schedule.



# STUDENTS POSTERS

*Before each school contact, students attended to lessons of their teachers on specific issues agreed with ARISS Mentor.*



**PROGETTO ARISS**

**COLLEGAMENTO RADIO CON LA STAZIONE SPAZIALE INTERNAZIONALE**

DALLA CITTADELLA MEDITERRANEA DELLA SCIENZA DI BARI  
SABATO 8 GENNAIO 2011 ORE 13.20

VIALE BIAGIO ACCOLTI GIL Z.I. BARI  
PER INFORMAZIONI: 080-5348882 / 080-5357653  
CELL 308/2128771  
WWW.CITTADELLAMEDITERRANEASCIENZA.IT  
WWW.SAITPUGLIA.IT

diretta live Streaming: [www.cittadellamediterraneascienza.it/webtv](http://www.cittadellamediterraneascienza.it/webtv) | PAOLO NESPOLI



Con il patrocinio Comune di Modugno

**COLLEGAMENTO CON LA STAZIONE SPAZIALE INTERNAZIONALE**

**Sabato 12 Marzo alle ore 11.24**

partecipano al collegamento la scuola secondaria di I grado "Francesco d'Assisi" e la scuola primaria 3° circolo "Don Lorenzo Milani" Modugno

dalla Cittadella Mediterranea della Scienza Viale Accolti Gil Z.I. Bari



**"Saint-Roch Étoiles"**

Qui Aosta... rispondete Stazione Spaziale Internazionale

in diretta dallo spazio  
**PAOLO NESPOLI**  
astronauta ESA per la Expedition 26 missione MagISSTra

contatto in condivisione con l'Istituto Comprensivo "G. Manzi" di Civitavecchia (Roma)

**sabato 26 marzo 2011; ore 9.15**

ISTITUZIONE SCOLASTICA SAINT-ROCH, CORSO IVREA 19 - AOSTA  
IN COLLABORAZIONE CON

*They were also asked to write newspaper articles, to draw posters dealing with the event.*



Istituto Comprensivo "via Toscana" Civitavecchia



Gli alunni dell'Istituto Comprensivo "via Toscana" di Civitavecchia contattano via radio ARISS (Amateur Radio on International Space Station) l'astronauta Paolo Nespoli in missione sulla ISS.

**SABATO 15 GENNAIO 2011**  
SALA CONFERENZE DELL'AUTORITA' PORTUALE  
MOLO VESPUCCI  
Ore 9,00 alle 12,00

vi aspettiamo!!!

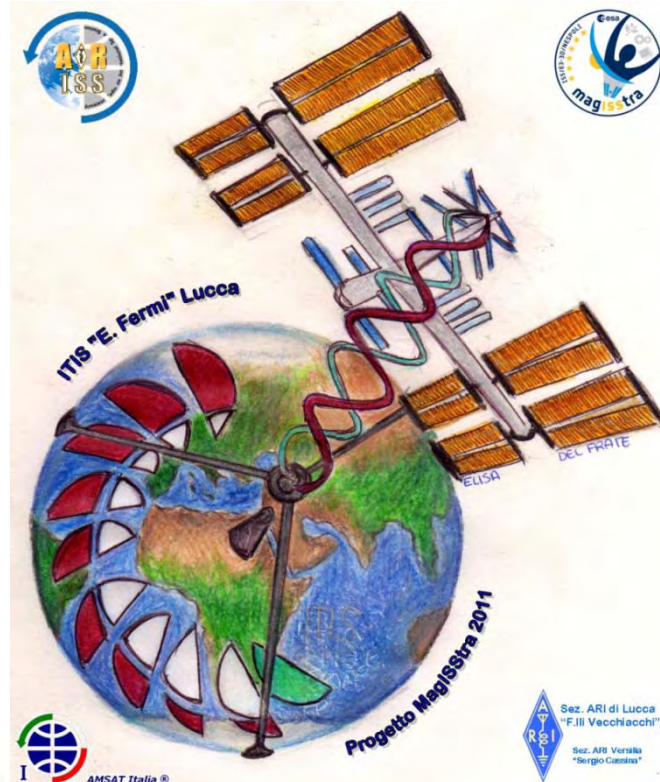

Sez. ARI di Lucca  
"F.lli Vecchiacchi"  
Sez. ARI Virolla  
"Sergio Cabassi"





# Set-Up beyond ARISS requirements during MagISStra mission



## School

## IK1SLD

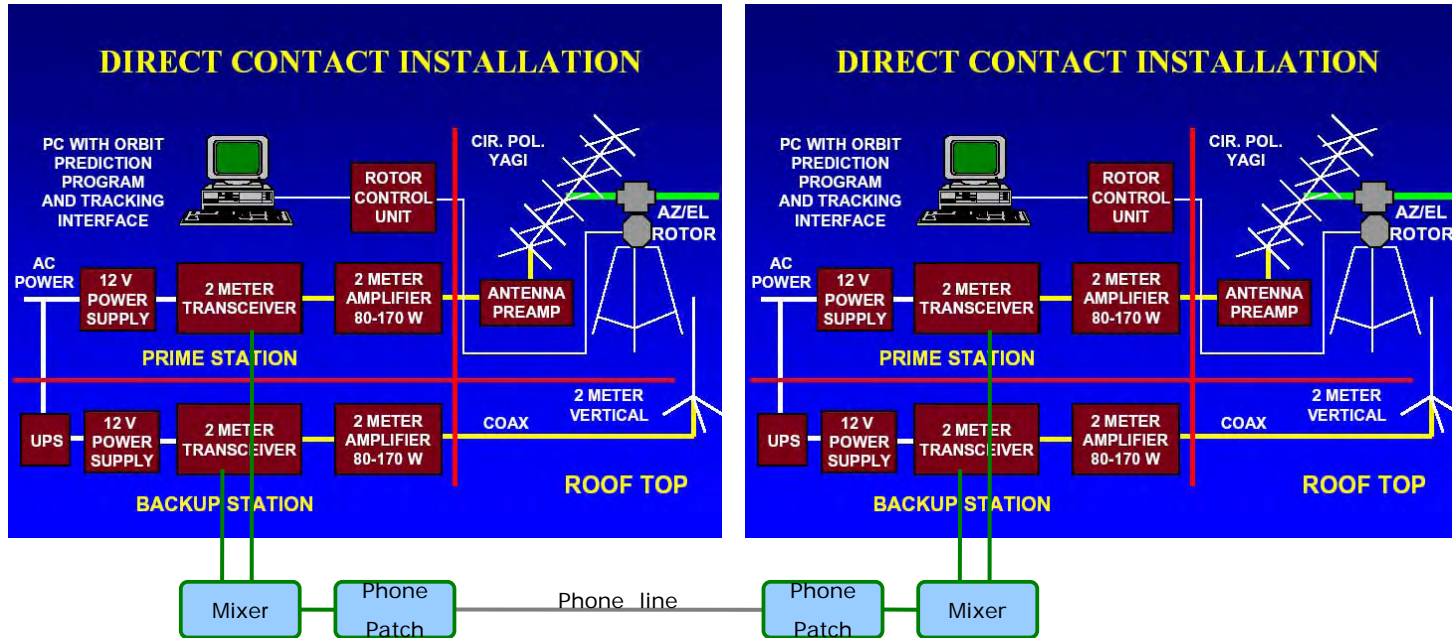

Any Italian school contact was organized in such a way to have a redundant telebridge contact by a remote station (hot back-up), in addition to the station installed in the school.





# Set-Up beyond ARISS requirements during MagISStra mission



### School 1

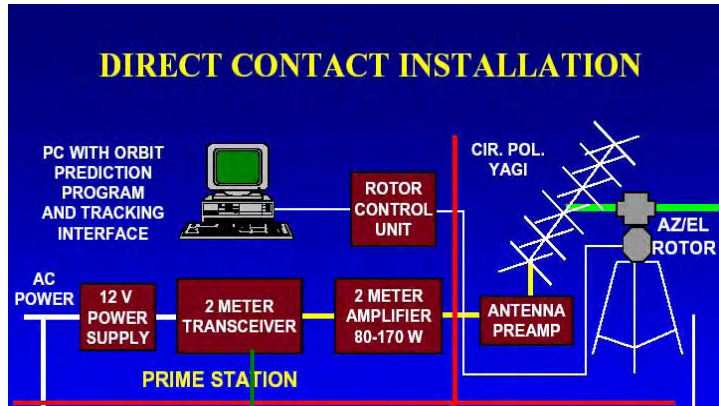

### School 2

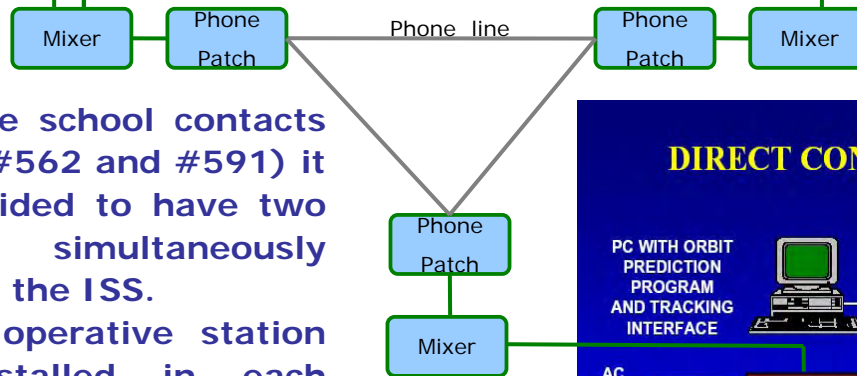
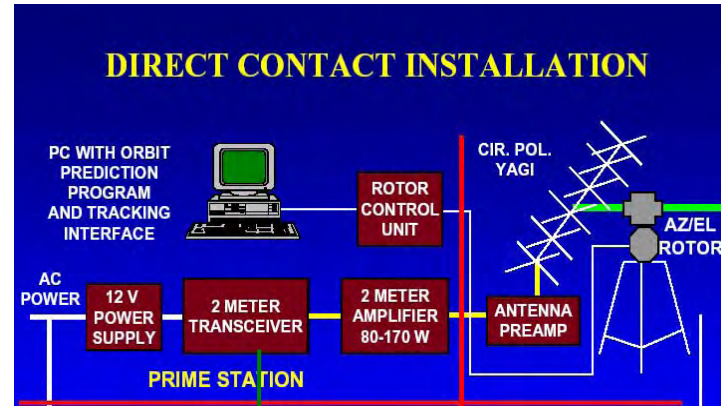

IK1SLD

For some school contacts (ARISS #562 and #591) it was decided to have two schools simultaneously linked to the ISS.

A fully operative station was installed in each school and the hot back-up, by a telebridge station, was also available for both.

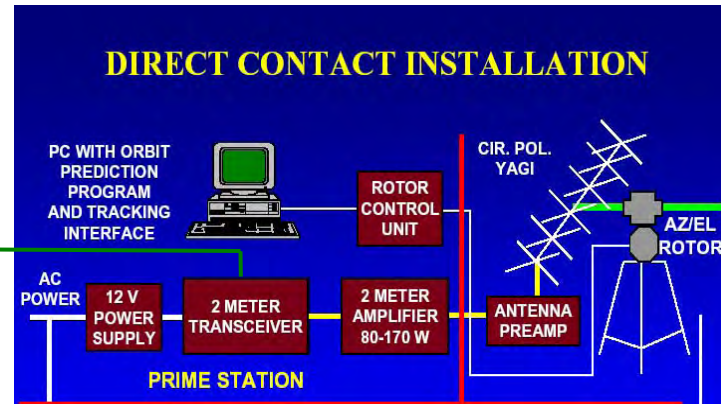



# Set-Up beyond ARISS requirements during MagISSTra mission



## School 1

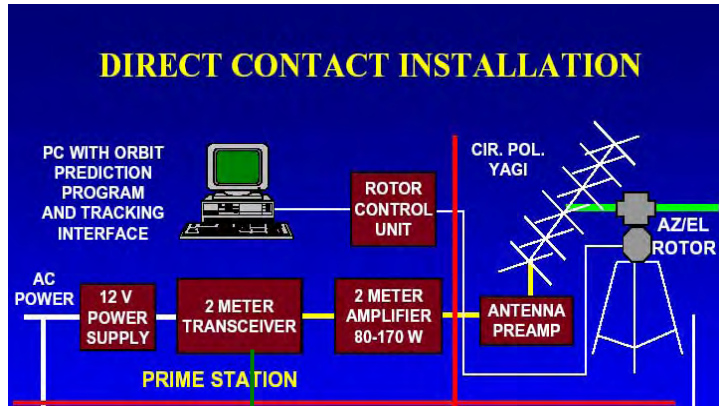

In some contacts two schools have shared the same event but only one was equipped with a station.

## School 2

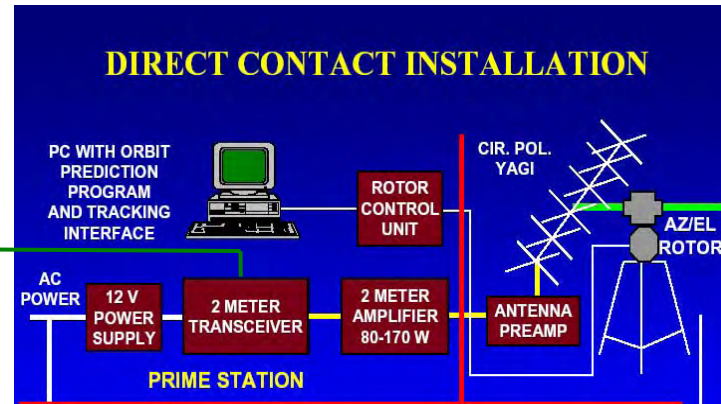
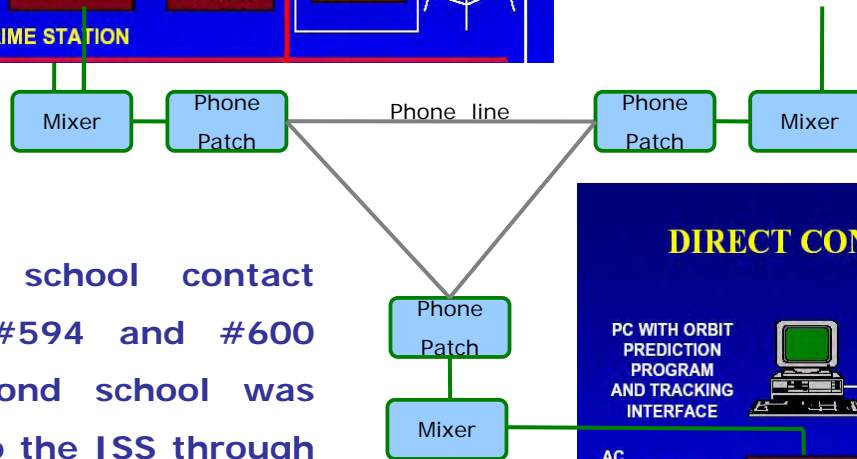

As for school contact ARISS #594 and #600 the second school was linked to the ISS through the first school or a telebridge station.





# Shared and Double contacts in Italy during MagISStra mission



★	★	1	567	Università degli studi di Bari	Bari
	★	2	569	Istituto Comprensivo Marco Polo-Viani	Viareggio, Lucca
	★	3	570	Istituto Suore Mantellate	Viareggio, Lucca
★	★	4	571	Istituto Comprensivo Via Toscana 2	Civitavecchia, Roma
	★	5	572	Istituto Corrado Melone	Ladispoli, Roma
	★	6	573	Istituto Comprensivo Ilaria Alpi	Ladispoli, Roma
	★	7	575	Istituto Comprensivo "Marco da Melo"	Mel, Belluno
★		8	578	Scuola Primaria "Alessandro Cialdi"	Civitavecchia, Roma
		9	583	Istituto Comprensivo "Fermi - Oggioni"	Villasanta, Monza
★		10	586	Osservatorio Astronomico Bologna	Bologna
		11	588	Istituto Superiore "Claudio Varalli"	Milano
★		12	589	"Imparare Sperimentando"	San Quirino, Pordenone
		13	595	ICS "Marco D'oggiono"	Oggiono, Lecco
★	★	14	597	Scuola Media "Francesco d'Assisi"	Modugno, Bari
	★	15	598	Scuola Media Don Milani	Modugno, Bari
★	★	16	603	SIP Cossar / Da Vinci	Gorizia
	★	17	604	Scuola Media "Elena Guerra"	Roma
		18	605	Istituto Comprensivo di Verano Brianza	Verano Brianza
★	★	19	607	Istituto Comprensivo "G.Manzi"	Civitavecchia, Roma
	★	20	608	Istituzione Scolastica "Saint-Roch"	Aosta
★	★	21	611	Istituto Tecnico Industriale "Da Vinci"	Pratola Peligna
	★	22	612	Scuola Media "Tedeschi"	Pratola Peligna
		23	613	Istituto Tecnico Industriale "Fermi"	Lucca
		24	615	Scuola Primaria "Tiro a Segno"	Fermo
		25	616	Scuola Primaria "Viale della Vittoria"	Montecosaro
		26	619	Istituto Sociale	Torino
★		27	622	Istituto Comprensivo "Dedalo 2000"	Cremona
		28	625	Accademia Aeronautica Militare	Pozzuoli, Napoli
		29	627	Scuola Media "Maccioni"	Nuoro
★		30	630	Istituto Tecnico Industriale "Mattei "	Maglie, Bari
★	★	31	631	Turin Flying Institute	Torino
	★	32	637	Istituto Tecnico Industriale "Montani"	Fermo
★	★	33	640	Primary school "Pasquale Luisi"	Castelluccio Valmaggiore, Foggia
	★	34	641	Scuola Media "Virgilio"	Castelluccio Valmaggiore, Foggia

**8 Shared contacts**

**13 contacts continued on next orbit**



**13 contacts on Saturday**

Blue text – Telebridge contacts

□ – Shared contacts

★ – Double contacts

★ – Saturday contacts





AMSAT Italia®

# 150th anniversary of the Italian unification during MagISStra mission





Saturday, 19 March, 2011 at 08:44 UTC and 10:17 UTC, i.e. 09:44 and 11:17 local time, "Cossar / Da Vinci" Institute in Gorizia AND "Elena Guerra" Middle School in Rome, Italy, established a double contact with Italian astronaut PAOLO NESPOLI, IZOJPA on board the International Space Station.



For celebrate the 150th anniversary of the Italian unification before LOS of second contact Nespoli received from earth the greeting form Italian students located in several (6) Italian regions.

All attended the celebration by teleconference established via phone line and VoIP between all sites involved.

ARISS Telebridge station IK1SLD provided the link with ISS for Piemonte, Friuli-Venezia-Giulia, Sardegna and Campania. IK0USO station installed at "Elena Guerra" Middle School in Rome provided the ISS link for the Lazio region. IZ7RTN, permanently installed at "Cittadella Mediterranea della Scienza" for ARISS and educational activities, provided the ISS link for the Puglia region.



-  IK1SLD telebridge station
-  Direct ground station at School
-  School

-  Phone line teleconference
-  Sky-PE teleconference
-  Webcast

**ARISS International Delegates Meeting - October 28-29, 2011- Houston**



AMSAT Italia®

# Telebridge station, ARISS Teams and HAM Radio Teams expertise of ARISS







ARISS program has been sustained in Italy by voluntary radio amateurs groups.

A telebridge station IK1SLD is permanently installed in Casale Monferrato, Piemonte.

An ARISS permanent station IZ7RTN is located in Bari, Puglia. Its staff, coordinated by IZ7EVR, has established ARISS Puglia Team which counts most of the school contacts in Italy.

The 2° ARISS Team is located at Erba, Lombardia.

Expert Groups for ARISS school contacts are located in Toscana and Lazio.

-  IK1SLD telebridge station
-  IZ7RTN station at University of Bari – ARISS Puglia Team
-  ARISS Team
-  HAM Radio Teams expertise of ARISS

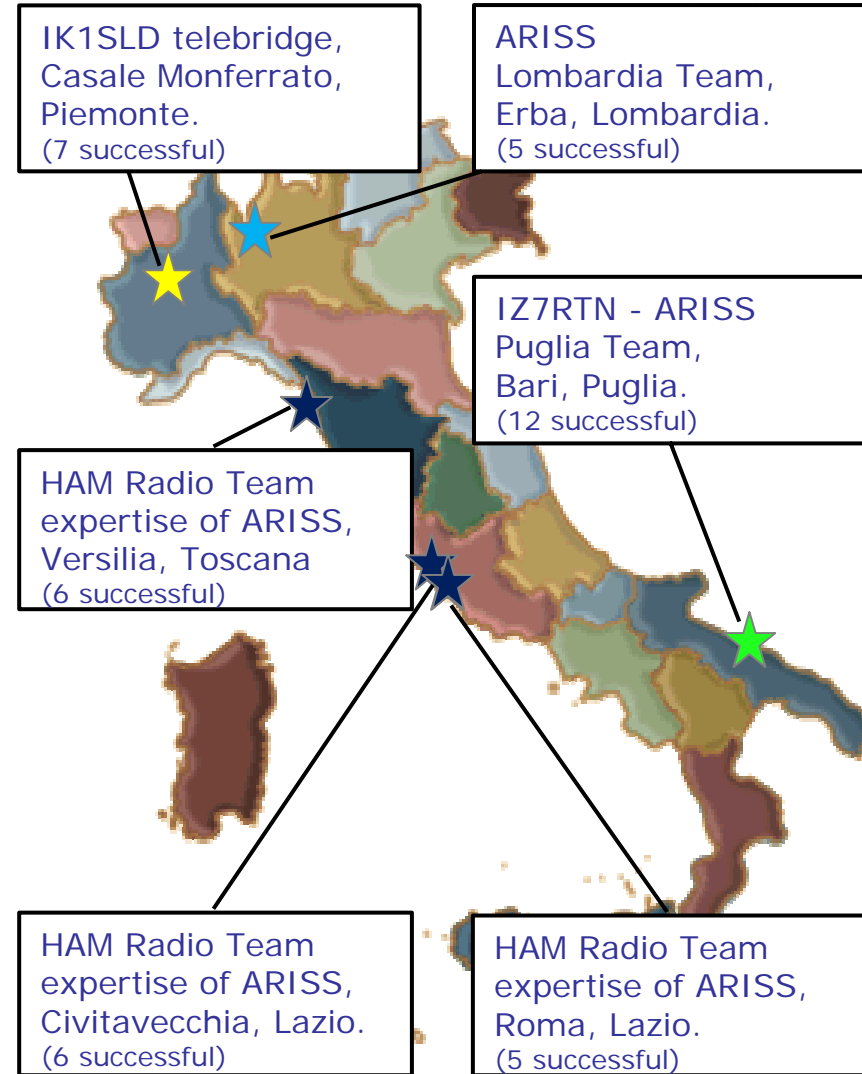



AMSAT Italia®

# ARISS 10<sup>th</sup> ANNIVERSARY



December 21, 2010 Paolo Nespoli celebrated the 10<sup>th</sup> anniversary of the first ARISS School Contact, addressing his greetings to the ARISS Community and wishing us a Happy Birthday.

*ARISS International Delegates Meeting - October 28-29, 2011- Houston*



# ISS 26-27 crew established a new ARISS record!

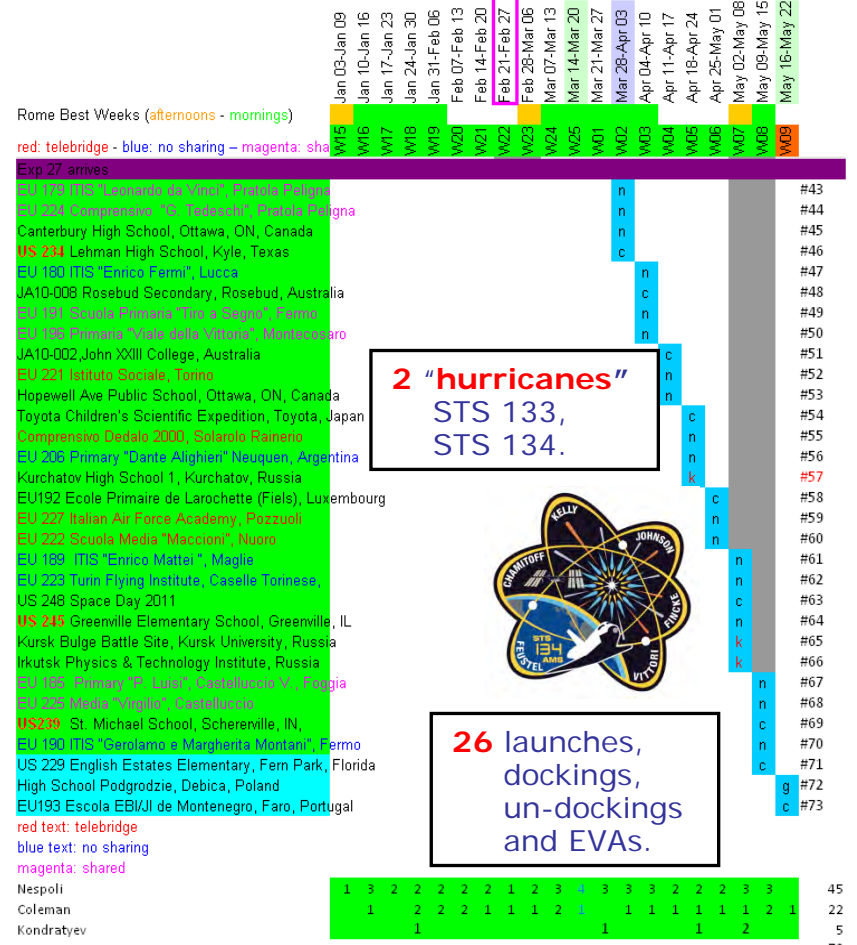

**Expedition 26/27 established a new ARISS record, working 77 schools in 68 radio contacts during the mission.**



AMSAT Italia®

# ESA Astronaut Paolo Nespoli, IZØJPA sets an ARISS milestone



Paolo Nespoli answered questions of students from **45** different schools, setting a new ARISS record for a astronaut for a single flight.

	Grand total number of events	Grand total number of contacts		Grand total number of events for a single flight	Grand total number of contacts for a single flight
ISS Op			ISS Op		
E. Michael Fincke KE5AIT	54	52	Expeditions		
Paolo Nespoli IZØJPA	48	40	Paolo Nespoli IZØJPA	26, 27	45
William McArthur KC5ACR	37	37	E. Michael Fincke KE5AIT	18	40
Frank De Winne ON1DWN	35	35	William Mc Arthur KC5ACR	12	37
Sunita Williams KD5PLB	33	33	Frank De Winne ON1DWN	20	33
Leroy Chiao KE5BRW	23	23	Sunita Williams KD5PLB	14, 15	33
Catherine G. Coleman KC5ZTH	22	22	Leroy Chiao KE5BRW	10	23
Frank Culbertson KD5OPQ	22	22	Catherine G. Coleman KC5ZTH	26, 27	22
Clay Anderson KD5PLA	21	21	Frank Culbertson KD5OPQ	3	22
Bob Thirsk W5/VA3CSA	20	20	Clay Anderson KD5PLA	15, 16	21
Jeff Williams KD5TVQ	20	20	Bob Thirsk W5/VA3CSA	20	20

But Paolo Nespoli did more. He managed **13** double contacts, continuing the dialogue with the students during the following orbit. This was his initiative, a proof of his interest in educational outreach.

During the ARISS contacts with the schools (Italian and other) Paolo Nespoli established a very special relationship with all participants who perceived his enthusiasm and his engagement to do ARISS contacts and to establish a dialogue with the young generation.

Paolo did a great job as radio amateur and communicator. This is an outstanding example of passion and enthusiasm for ARISS activities on behalf of an astronaut attentive to the educational objectives of the ARISS program and demonstrating the possibilities of amateur radio.

**ARISS International Delegates Meeting - October 28-29, 2011- Houston**



Almost all Nespoli contacts with Italian schools were broadcasted over Internet by live video streaming on AMSAT Italia video channel:

[http://www.livestream.com/AMSAT\\_Italia](http://www.livestream.com/AMSAT_Italia)

*ARISS International Delegates Meeting - October 28-29, 2011- Houston*





AMSAT Italia®

# ESA ANNOUNCEMENTS



The screenshot shows the ESA Italia website interface. At the top, the ESA logo and 'italia' text are visible, along with the 'European Space Agency' name. Below the header, there's a navigation menu on the left with categories like 'Chi siamo', 'Alcuni approfondimenti', and 'Astronauti'. The main content area features a news article titled 'Dalla Puglia al Piemonte con ARISS e Paolo Nespoli' dated 5 Maggio 2011. The article includes a satellite image of Italy and text describing Paolo Nespoli's activities and school contacts. A right sidebar contains a date '02-Jun-2011', a 'MagIStra mission' banner, and a 'Maggiori informazioni' section with links to ARISS, Amsat Italia, and webstreaming contacts.

**ESA Astronaut Paolo Nespoli conducted many contacts with Italian schools, supported by an agreement between ESA/ESRIN and AMSAT Italia. Each school contact was announced by web story on ESA Portal - National News.**

***ARISS International Delegates Meeting - October 28-29, 2011- Houston***

## ARISS Facts for ISS 26 – 27 Exp.

- more than **10.000** students involved in ARISS contacts;
- more than **200** Hams worked for success of ARISS contacts;
- **77** schools, i.e. more then **1500** questions put to ISS crew;
- ...during the ARISS event at the Italian Air Force Academy, one cadet declared that he has chosen his professional life, because he participated to an ARISS school contact when he was a young student.



[www.amsat.it](http://www.amsat.it)

Thanks a lot...

...and good luck !

73, IZØJPA and IKØWGF