

# MAREXMG

SpaceCam2  
Status Report

project manager  
G. Miles Mann WF1F

# Introduction

The MAREXMG SSTV System is an entry-level PC based Slow Scan Television system designed to be used on board the International Space Station. The name of the MAREXMG SSTV project will be called the SpaceCam2 project. This system will support the common SSTV transmission modes including Digital SSTV. The SpaceCam2 project has been specifically designed to be accessible to as many stations as possible around the world. The original proof-of-concept system was built by the MAREXMG team and successfully flown on the Russian Space Station Mir (December 1998 until August 1999). The proof-of-concept system has proven the ability of the hardware design and it has taught us how to make additional improvements for the next generation SSTV system for ISS.

# Hardware / Software Overview

The basic components of the SpaceCam2 project will consist of a software application, which will run on the Station Support Computer (SSC), and ,an audio interface cable.

The SpaceCam2 project will build upon the ISS-Ham VHF project.

The SpaceCam2 project will be plug-compatible with the ISS-Ham project and will add two-way SSTV support to the ISS-HAM VHF project.

MAREX-NA ISS SpaceCam 1 Beta 1 Build 001

## MAREX-NA ISS SpaceCam 1



Portions © (1999) Silicon Pixels USA

**Robot 36**  
**Robot 72**  
**Scottie S1**  
**Scottie S2**  
**Martin M1**

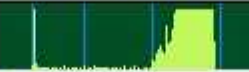

7%

Auto-Save  
 Lock Mode



MANUAL    REPEATER    SETTINGS



DEFAULT   LIBRARY   REPEATED   CREW   **USER**



**C: \SSTV Images**

```

20:42:18 MAREX-NA SpaceCam 1 (Beta 1 Build 001 13-March-2000)
20:42:18 Main window loaded
20:42:18 Setting DSP filter: Bandpass
20:42:18 Initializing preview grids
20:42:19 Initializing VFW interface
20:42:21 Logitech QuickCam VC USB
20:42:21 Live window
                
```

**Slide Show ON (O)**        

**Slide Show OFF (F)**    Slide Show disk path (Use DISK icon)  
C:\SSTV IMAGES\

**TRANSMIT (T)**         Enable video

**RECEIVE (R)**    (C)

**Auto-RECEIVE (A)**    **STANDBY / ABORT (S)**

**RE-SYNC (Y)**    Refresh Preview Grids

# Laptop CPU and Memory Requirements

Operating System	CPU Speed	Ram Megabyte	Ram Megabyte Video
Windows 95	400 MHZ	64	2
Windows 98	400 MHZ	128	4
Windows NT/2000	400 MHZ	256	4

## SpaceCam2 System requirements:

Memory requirements during operation

11MB

Disk requirements for full installation

10MB

Additional disk storage for images.

Variable

# Software Status

- The SpaceCam2 Software development is 10% completed.
- Features pending: Digital support.
- Any future ARISS requested features

# Hardware Status

- No Hardware changes required to the existing ISS-Ham station.
- Need to confirm which Laptop will be used.
- Digital SSTV needs a 400Mhz CPU

# Schematic

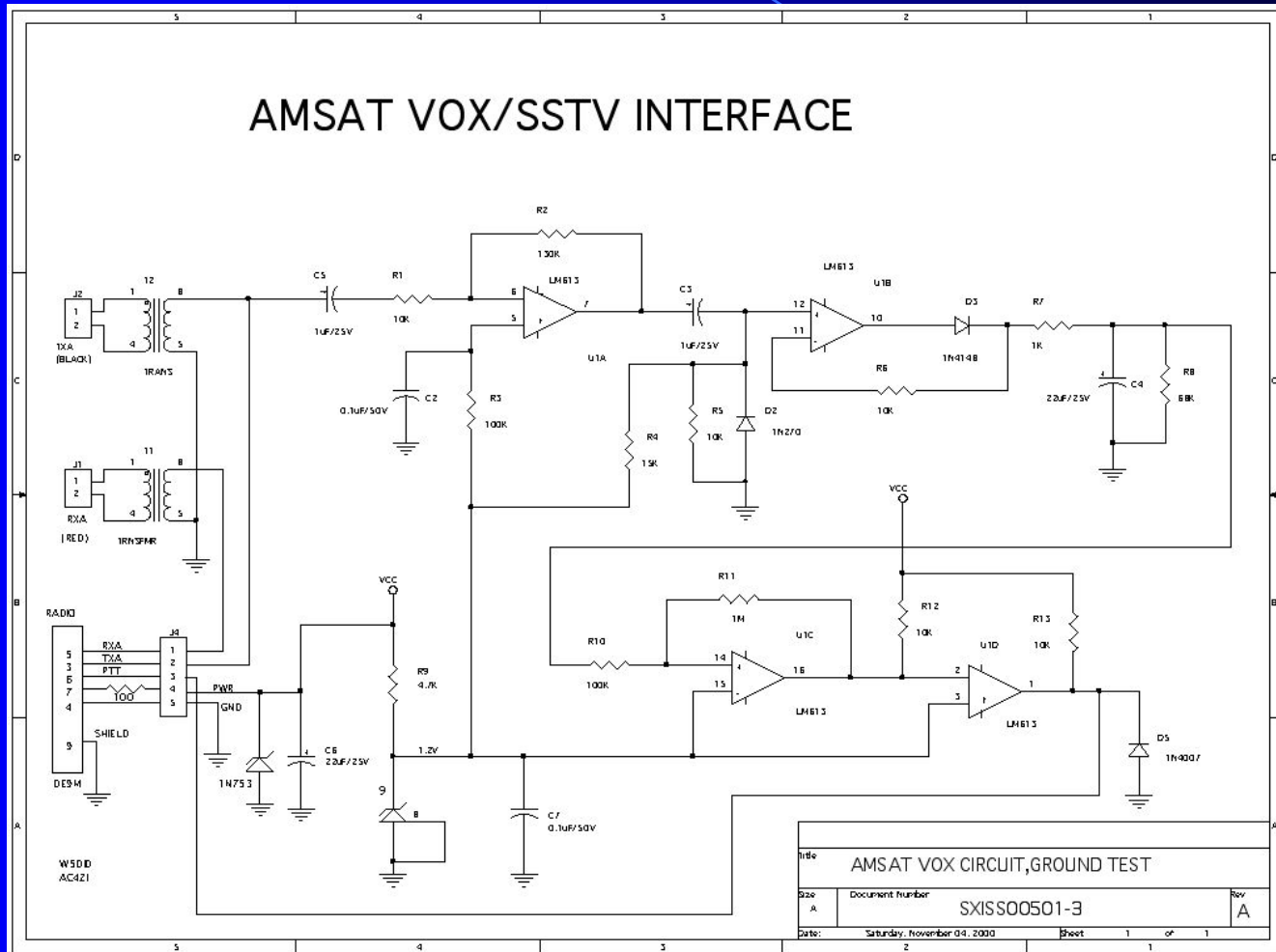



# Testing

Farrell Winder and the MAREX team have been actively testing the old software with Lou's new Audio Box.



# Testing Cont.

The image on the left shows the size of the Audio Adapter box required to connect the SSC to the AIRSS Amateur Radio System.



# TESTING SSC

- Digital testing expected to begin in the Summer of 2004

# Outstanding Issues

- ARISS Approvals
- Test Radios

# Development Schedule

**First Build**                      **Q3 2004**

**SpaceCam2 Alpha 20**      **Q4 2004**  
Completed

**SpaceCam2 Alpha 30**      **Q1 2005**  
Completed

# Development Schedule cont.

**SpaceCam2 Flight Ready**

**June 2005**

The final version of software will be delivered to ARISS

NASA and Energia will be issued software licenses to use and copy the SpaceCam2 software as needed for the ISS-Ham project.



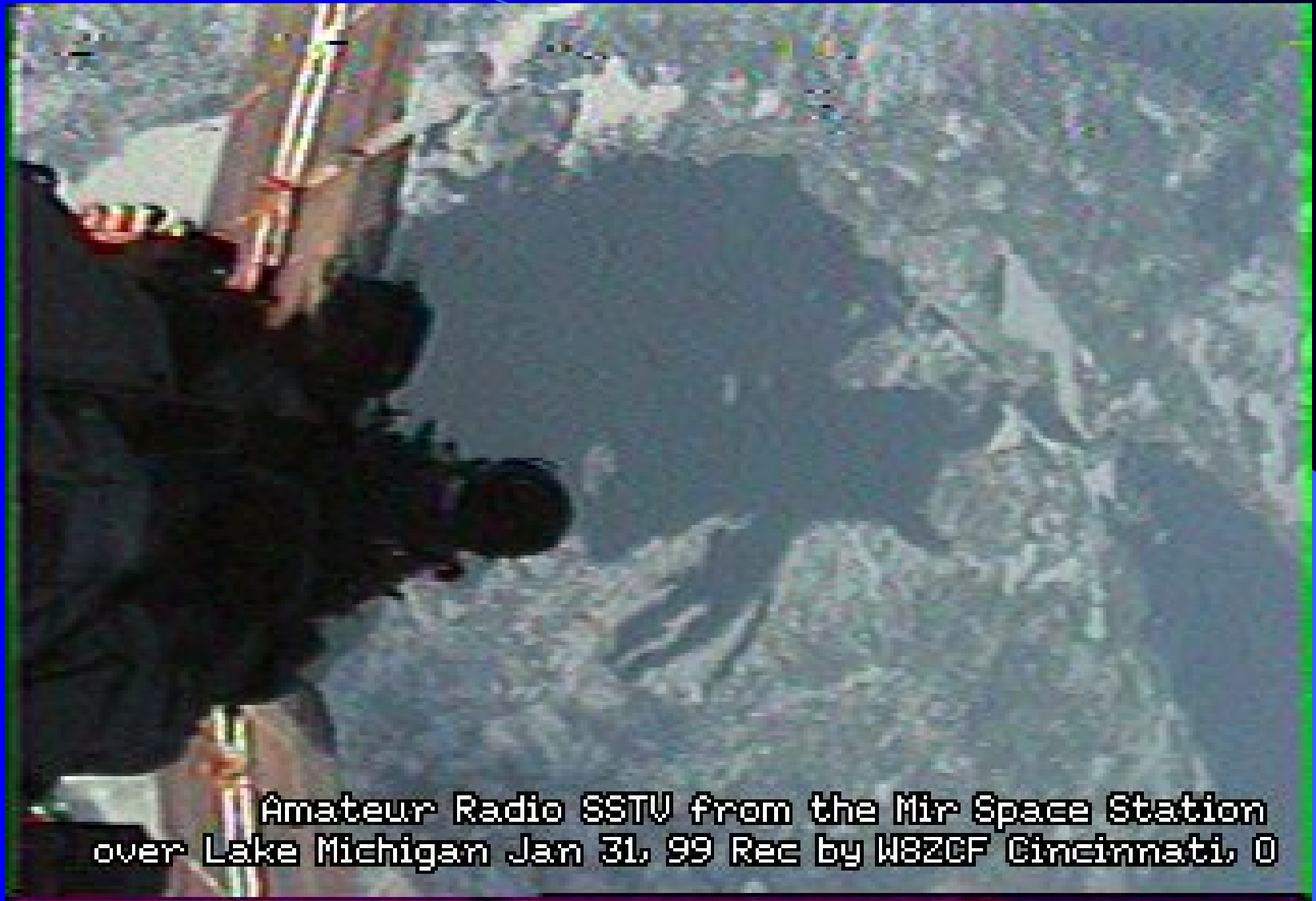

Amateur Radio SSTV from the Mir Space Station  
over Lake Michigan Jan 31, 99 Rec by W8ZCF Cincinnati, O



JAN 31, 1999  
Bowling Green KY  
RCV: W4HTB





Sergei Avdeyev

Jean-Pierre Haignere

Mir SSTU Feb 22 99 11:33 UTC Rec by W8ZCF



Mir Space Stn  
Dec 12, '98  
18:59 UTC

Rx W8ZCF Cinti, O

Mir Space Station  
09:01U  
Jan 1 99

Gennadiy/Sergei  
Say Happy New Year  
via Amateur Radio SSTV  
Rec by W8ZCF

